



ANKA
P R E F A B R İ K

Kalite ve Estetiğin Birleşimi





İÇİNDEKİLER

KONTEYNER MODELLERİ **1-9**

PREFABRİK EV MODELLERİ

| | | |
|-----------------------|---------------|-----------|
| ANKA | 49 m2 | 11 |
| KUTUP | 59 m2 | 12 |
| DOĞA | 61 m2 | 13 |
| YASEMİN | 69 m2 | 14 |
| ASİL | 75 m2 | 15 |
| CENNET | 81 m2 | 16 |
| KEMALPAŞA | 82 m2 | 17 |
| ZEBRA | 83 m2 | 18 |
| SİRİUS | 84 m2 | 19 |
| VEGA | 103 m2 | 20 |
| PETERSON KÖŞKÜ | 120 m2 | 21 |
| YEŞİL KÖŞK | 124 m2 | 22 |
| MENEKŞE | 128 m2 | 23 |
| MERKÜR | 148 m2 | 24 |

AN 01 MODEL

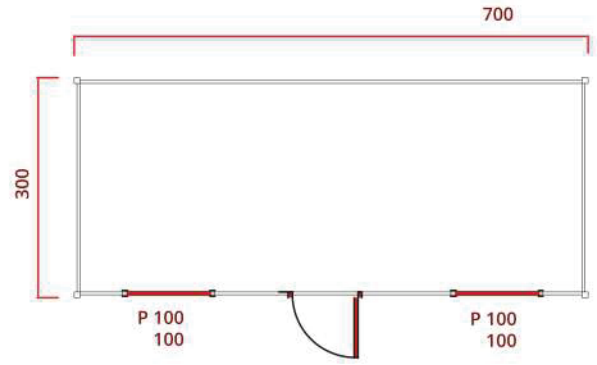

AN 02 MODEL

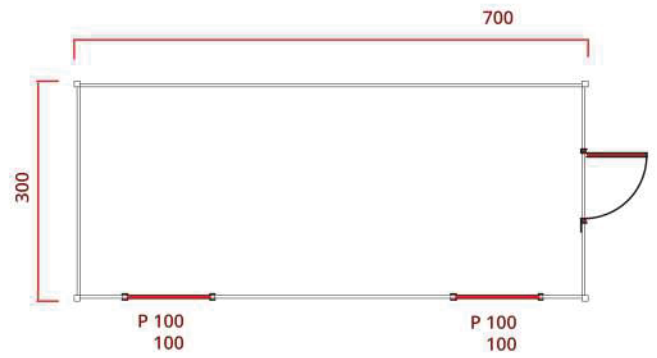

AN 03 MODEL

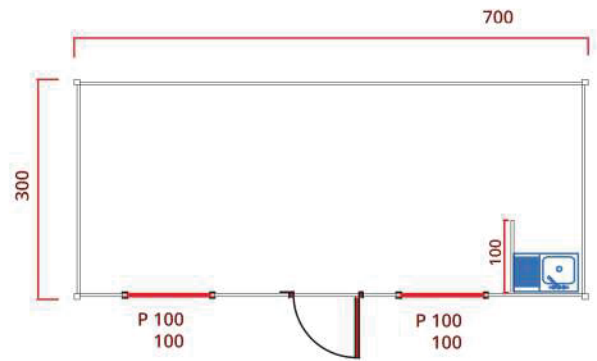

AN 04 MODEL

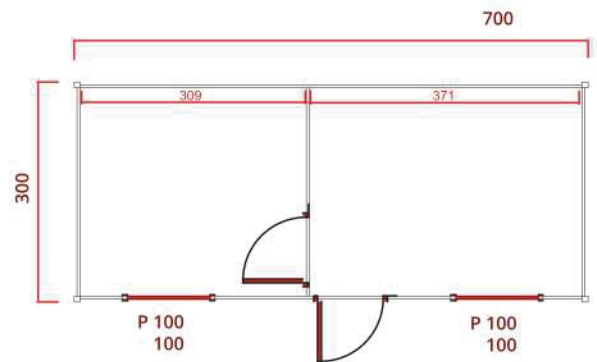

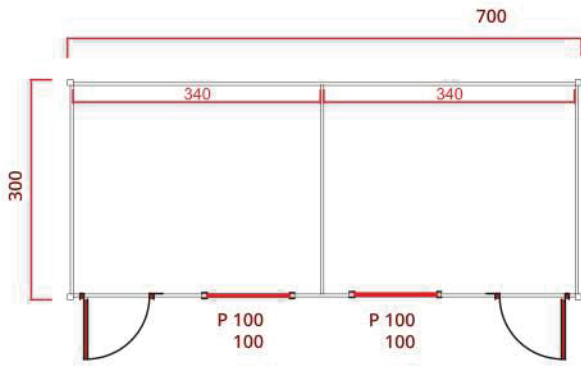

AN 05 MODEL

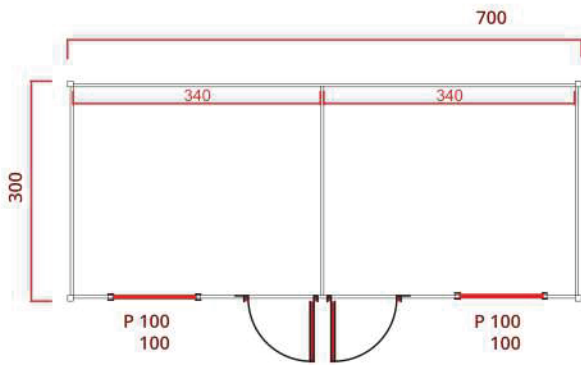

AN 06 MODEL

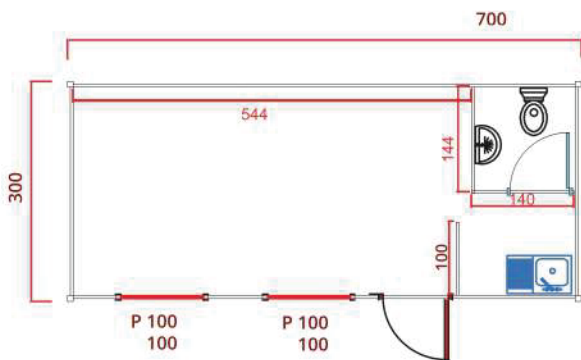

AN 07 MODEL

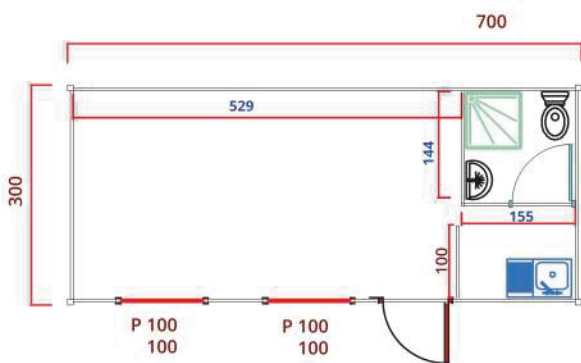

AN 08 MODEL



AN 09 MODEL

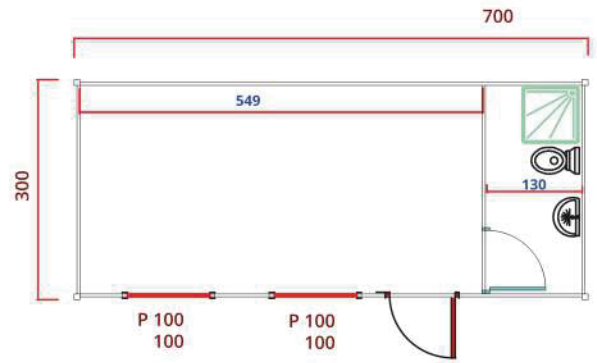

AN 10 MODEL

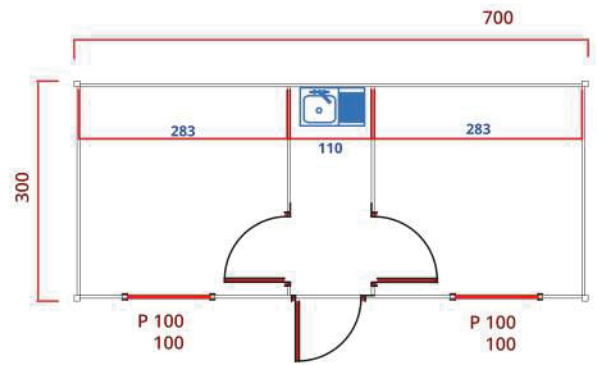
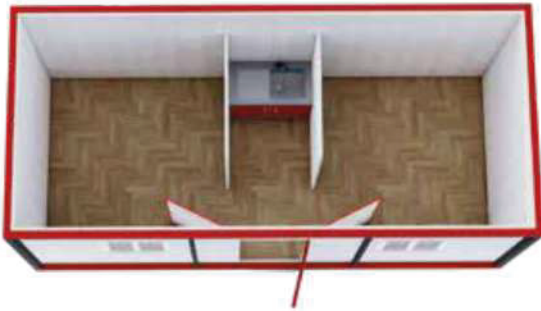

AN 11 MODEL

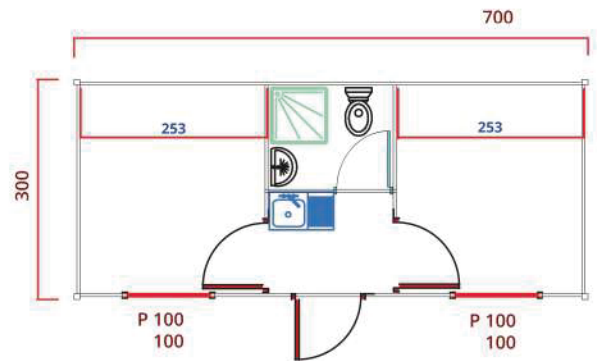
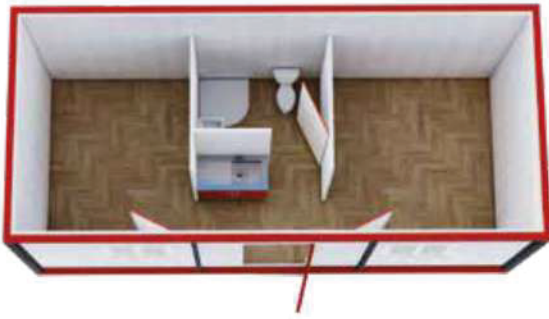

AN 12 MODEL

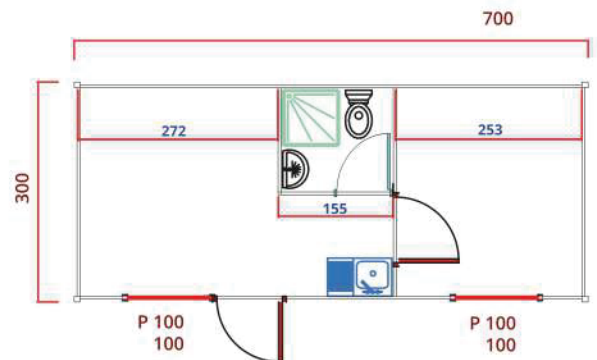
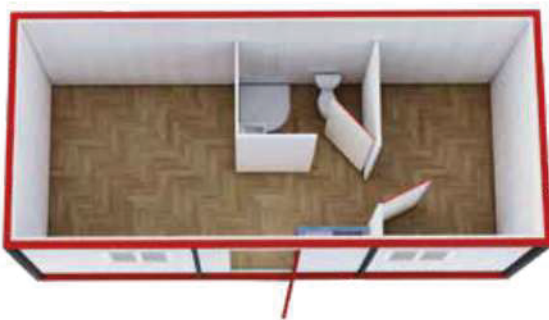

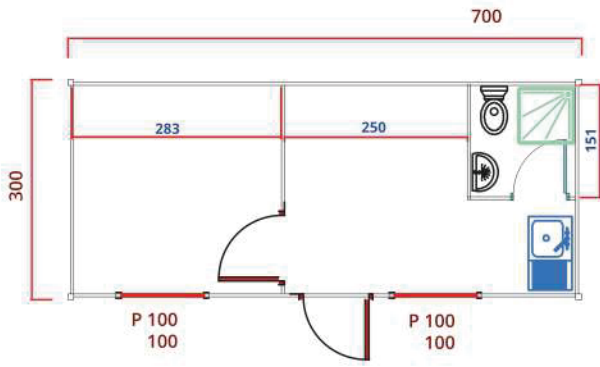

AN 13 MODEL 

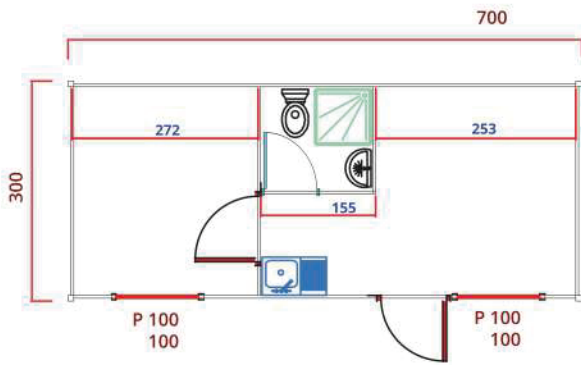
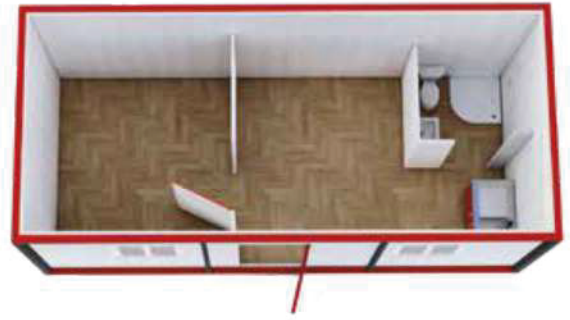

AN 14 MODEL 

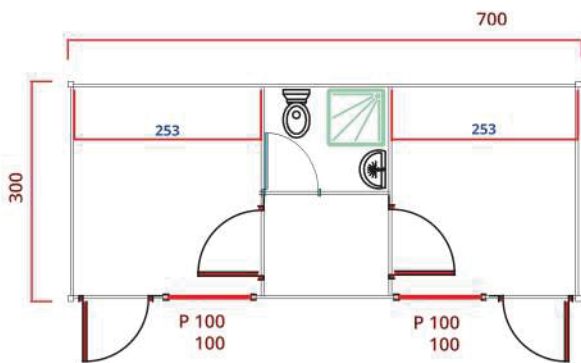
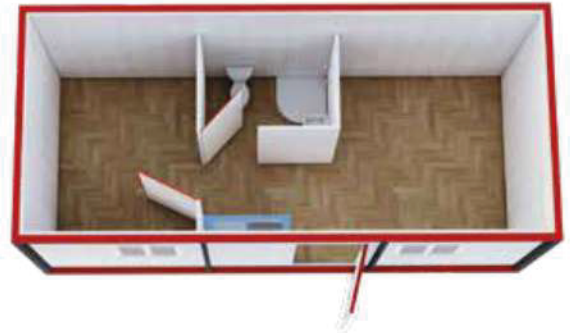

AN 15 MODEL 

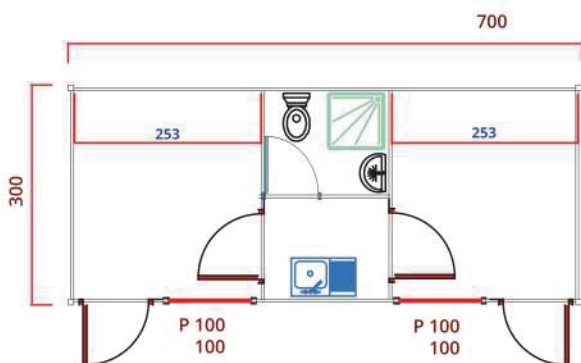
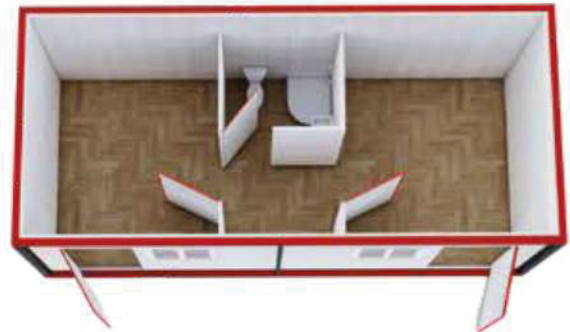

AN 16 MODEL 

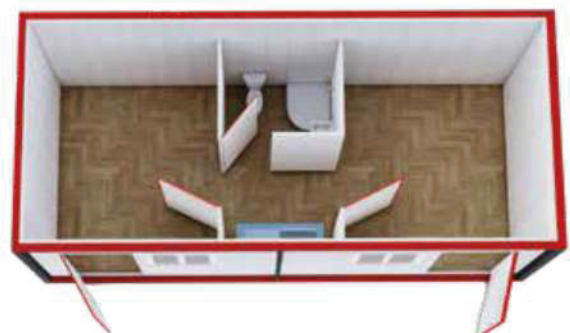

ANKA-641 WC

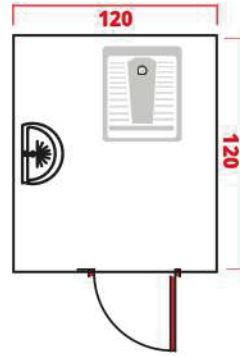

ANKA-642 WC

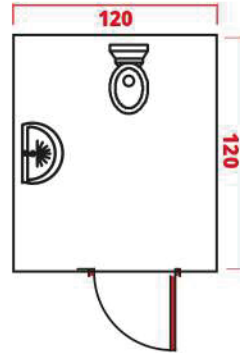

ANKA-643 WC

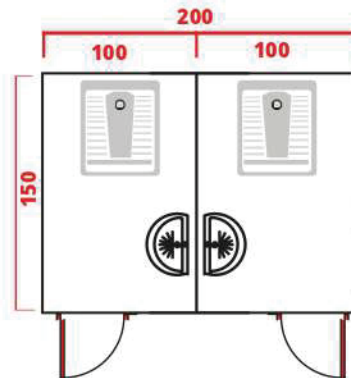
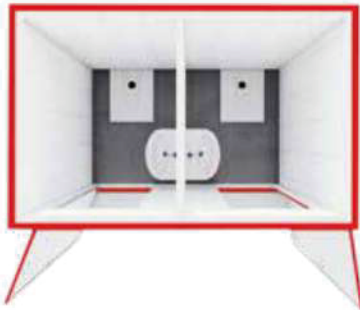

ANKA-644

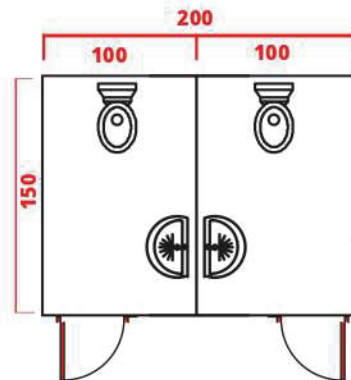

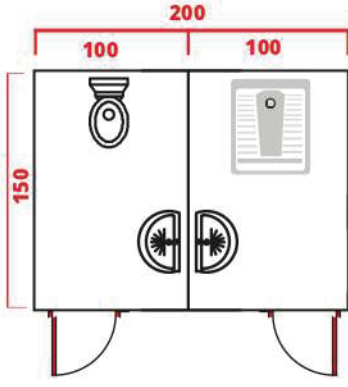

ANKA-645 WC

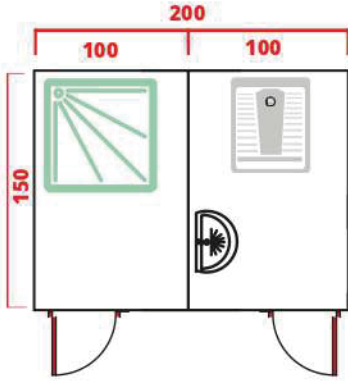
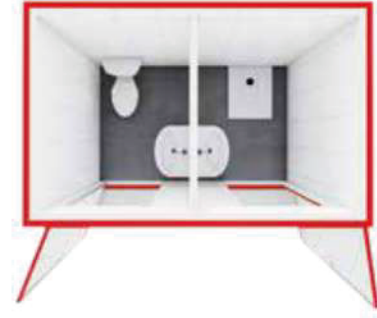

ANKA-646 WC-DUŞ

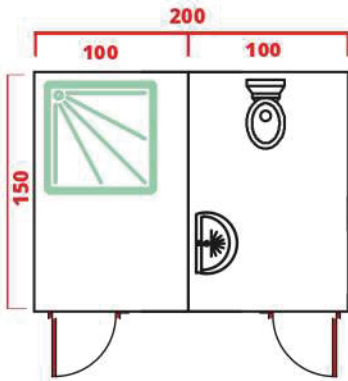

ANKA-647 WC-DUŞ

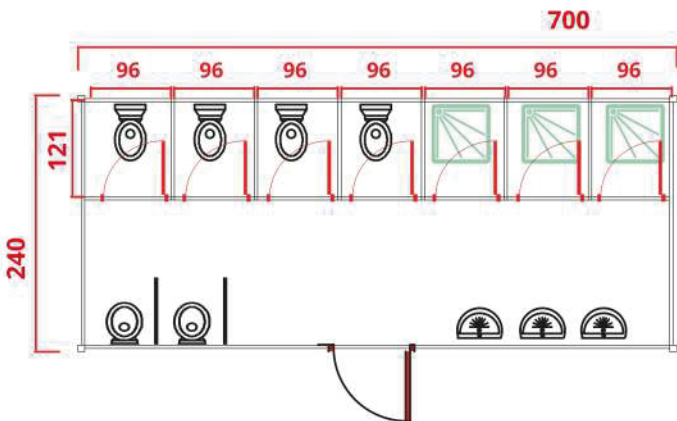

ANKA-648 WC-DUŞ

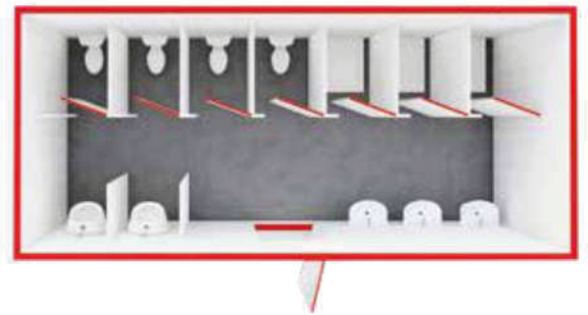

ANKA-501 GÜVENLİK

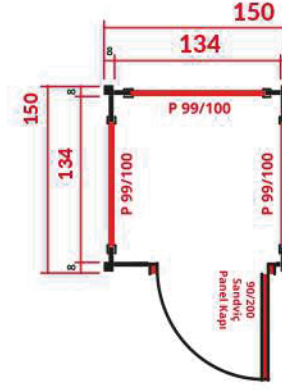

ANKA-502 GÜVENLİK

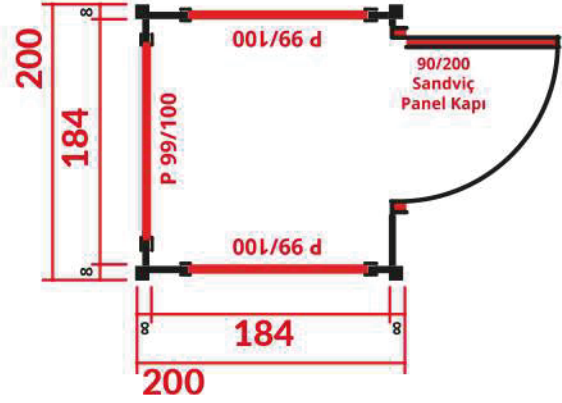

ANKA-503 GÜVENLİK

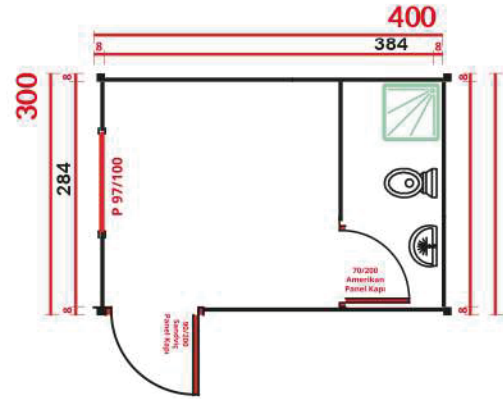

ANKA-504 GÜVENLİK

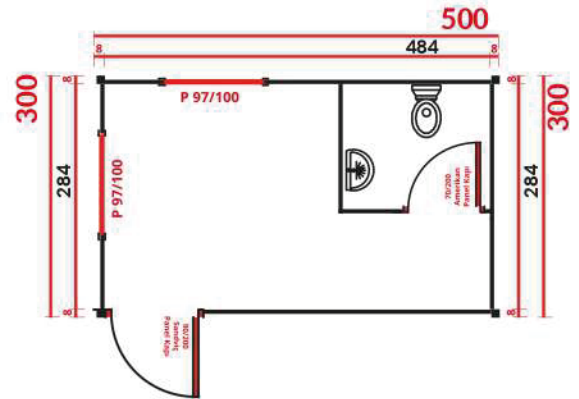
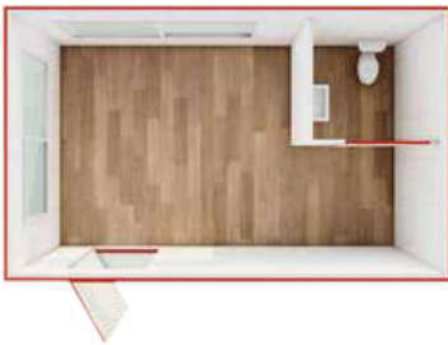

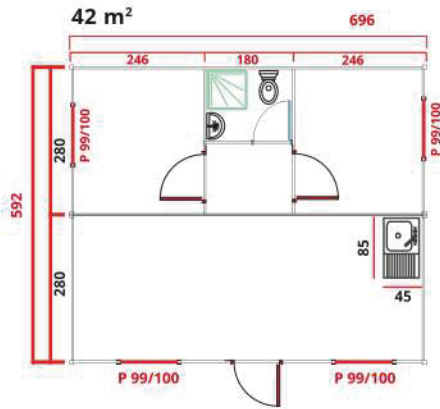

ANKA-701

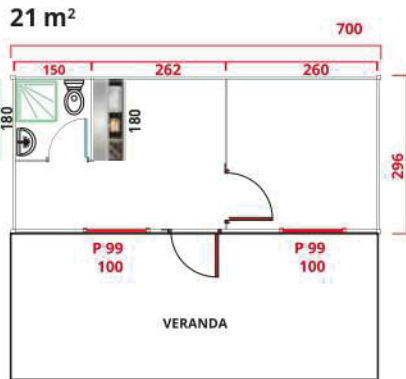

ANKA-702



ANKA-703



ANKA-704



ANKA-705



42 m² İki Kat 300x700



ANKA-706



51 m² İki Kat 300x700

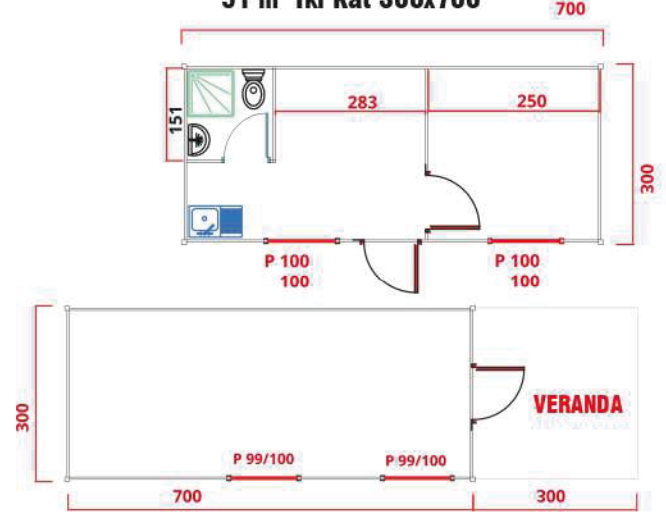

ANKA-707



42 m² İki Kat L 300x700

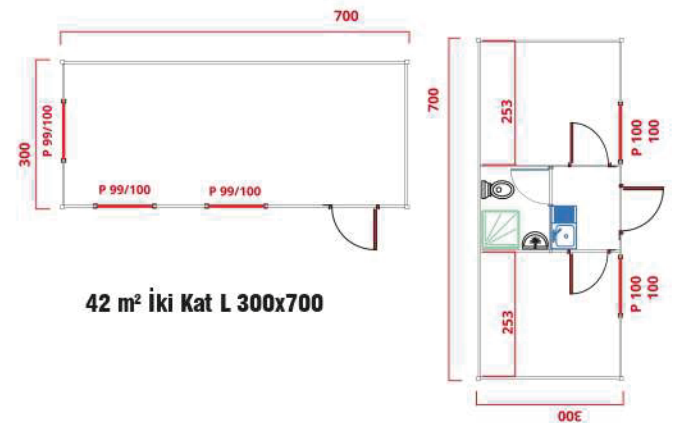

KONTEYNER TEKNİK ÖZELLİKLERİ



DUVAR

iç ve dış cephelerin tamamında galvaniz rall 9002 fırın boyalı sac arasında 40 dn polüreten panel dolgulu 40 mm kalınlığında sandviç paneller kullanılır. Sandviç panel malzemesi piyasada ki en kaliteli cephe malzemelerinden olup 10 yıl paslanmaya karşı garantilidir. (maka tekno panel)

TAVAN KAPLAMASI



Tavana 12,5 mm kalınlığında beyaz renk pvc lambiri uygulanır. Tavan arasına yalıtım amaçlı 80mm kalınlığında cam yünü döşenir. Camyünü yanmazdır ve ısı yalıtımı özelliğine sahiptir.



ZEMİN KAPLAMASI

İmalatı yapılan çelik karkas üzerine 14 mm kalınlığında betopan civata ile uygulanır. Üzerine PVC mineflo kaplama uygulanır ve köşelere süpürgelik döşenerek şık bir görünüm kazanır.

ÇATI KAPLAMASI



Trapez kesitli 0,50 mm kalınlığında galvanizli sac ile kaplanır. Yağmur suları konteyner içindeki gizli yağmur oluklarından dışarı tahliye edilir. Konteyner kar yükü 80 kg/m2 olarak hesaplanmıştır. Dış görünümünden bakıldığı zaman çatı görünmez.



TAŞIYICI AKSAMLAR

Alt ve üst şasede kullanılan özel bükümlü sacların tamamı 2mm kalınlığında siyah sacdan imal edilmektedir. Alt şasede 40x80x1.5 mm kalınlığında kutu profiller kullanılmaktadır.

ELEKTRİK TESİSATI



Tüm prizlerde 3x2,5 TTR ve tüm aydınlatmalarda 2X1,5 kablo kullanılmaktadır. (TSE) BELGE Elektrik tesisatı siva üstü çekilmekte olup priz ve anahtarlar kullanılmaktadır.



KAPI

İç kapılar pvc doğrama kapı, Dış kapılar Polireten kapı kullanılmaktadır.

PENCERE



Pencereler tüm pencereler PVC doğrama, tek cam olarak takılır.



İÇ MEKAN MONTAJ ELEMANLARI

Mutfak evyesi 45X85 cm ölçülerde, Duş teknesi 80X80 cm ölçülerde krom, Ayaklı lavabo ve klozet rezervuarlı olarak yerleşim projesine göre yerleştirilir.



ANKA
P R E F A B R İ K

1+1

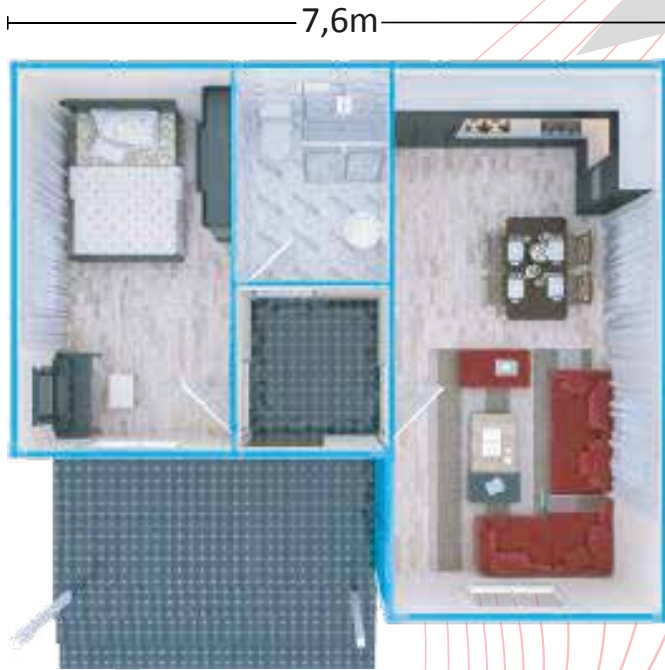

49m²

Huzur Dolu Bir Yaşam İçin

| | |
|----------------|--------------------|
| - Salon Mutfak | 19,4m ² |
| - Yatak Odası | 10,9m ² |
| - Banyo | 4,3m ² |
| - Antre | 3,3m ² |
| - Balkon | 8,2m ² |

1+1



Huzur Dolu Evler

- Salon 21,2m²
- Mutfak 11,6m²
- Yatak Odası 7,8m²
- Banyo 3,5m²
- Antre 2,2m²
- Balkon 9m²

59m²

2+1

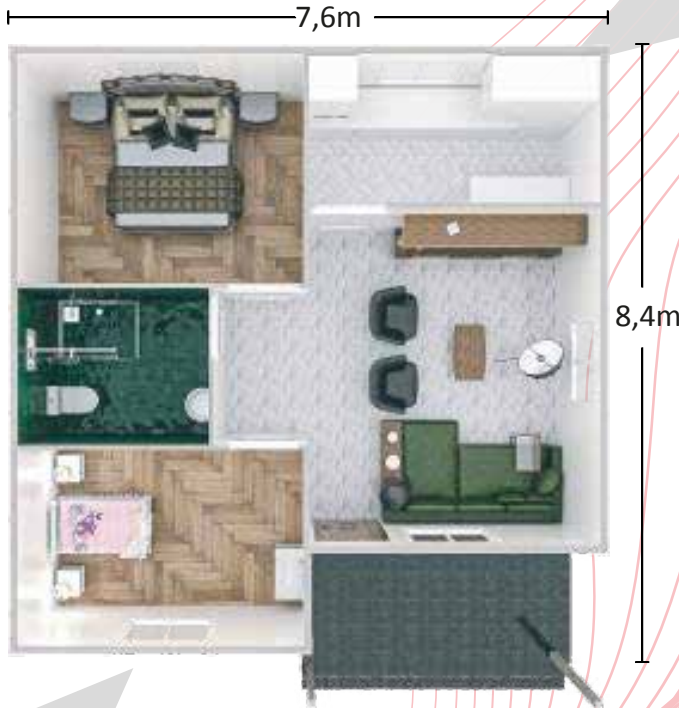

61m²

Bütçenize Uygun Yapılar

| | |
|----------------|--------------------|
| - Salon Mutfak | 23,3m ² |
| - Yatak Odası | 10,6m ² |
| - Çocuk Odası | 9,1m ² |
| - Banyo | 4,9m ² |
| - Antre | 2,4m ² |
| - Balkon | 7,2m ² |

YASEMİN

61 m

2+1



Stresten Uzak Yaşam Alanı

- Salon 18,4m²
- Mutfak 5,4m²
- Yatak Odası 14m²
- Çocuk Odası 9,2m²
- Antre 5,4m²
- Banyo 4,7m²
- Balkon 6,7m²

69m²



2+1



En Güzel Anılarınız İçin

| | |
|---------------|--------------------|
| - Salon | 16,1m ² |
| - Mutfak | 8,9m ² |
| - Yatak Odası | 11,5m ² |
| - Çocuk Odası | 9,1m ² |
| - Banyo | 5,9m ² |
| - WC | 2,8m ² |
| - Antre | 8,6m ² |
| - Balkon | 9,4m ² |

CENNET

81 m

2+1



9,6m



8,5m

| | |
|---------------|--------------------|
| - Salon | 19m ² |
| - Mutfak | 8,8m ² |
| - Yatak Odası | 13,8m ² |
| - Çocuk Odası | 11,3m ² |
| - Banyo | 5,4m ² |
| - Antre | 7,5m ² |
| - Balkon | 6,9m ² |
| - Giriş | 3,4m ² |

81m²

KEMALPAŞA

82 m

2+1



1.Kat

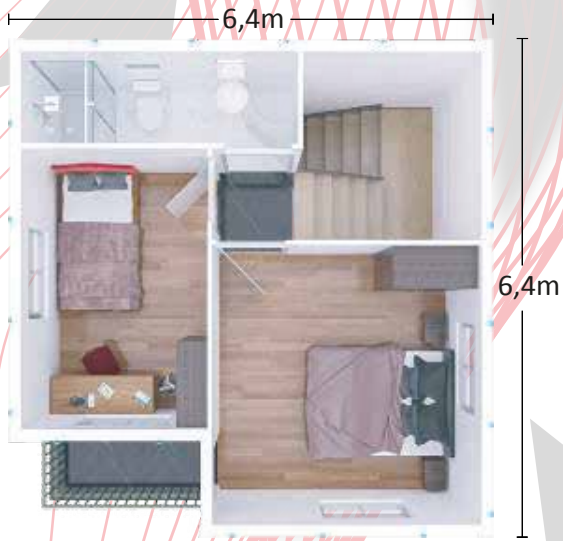

2.Kat

82m2

- Salon 13,6m2
- Mutfak 9,1m2
- Banyo / WC 3m2
- Balkon 3,1m2
- Merdiven 6,1m2
- Antre 3,3m2

- Yatak Odası 13,6m2
- Çocuk Odası 9,1m2
- Banyo 4,6m2
- Balkon 3,1m2
- Merdiven 6,1m2
- Antre 1,5m2

ZEBRA
83 m

2+1

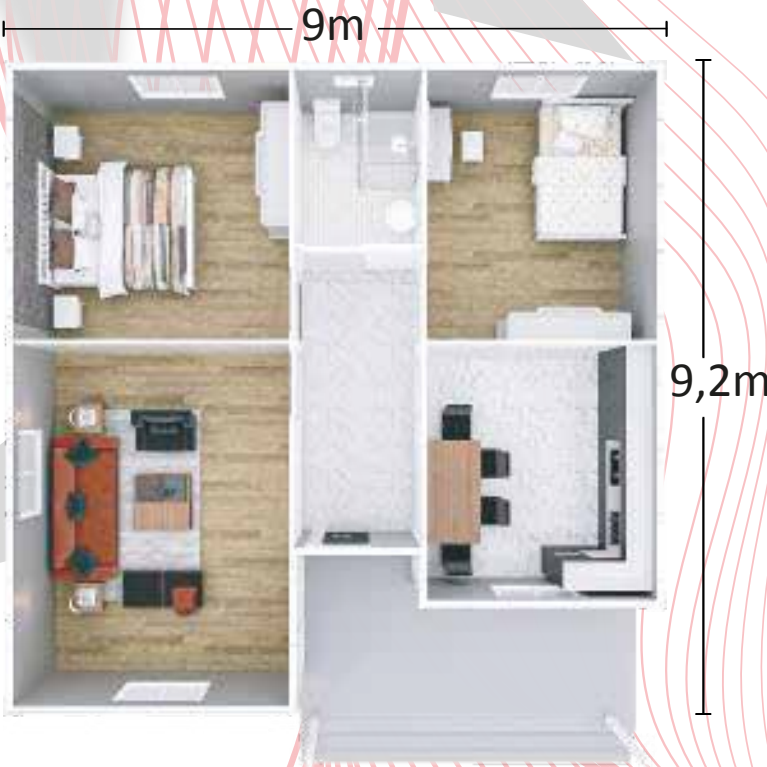

Keyif ve Huzur İçin

| | |
|---------------|--------------------|
| - Salon | 18,6m ² |
| - Mutfak | 10,1m ² |
| - Yatak Odası | 13,8m ² |
| - Çocuk Odası | 11,6m ² |
| - Banyo | 4,2m ² |
| - Antre | 7,2m ² |
| - Balkon | 12,1m ² |

83m²

2+1



9,5m



8,9m

Şehrin Karmaşasından Uzak

| | |
|---------------|--------------------|
| - Salon | 21m ² |
| - Mutfak | 8,9m ² |
| - Yatak Odası | 11,1m ² |
| - Çocuk Odası | 11,1m ² |
| - Banyo | 4,5m ² |
| - WC | 2,9m ² |
| - Antre | 7,2m ² |
| - Balkon | 12,3m ² |

84m²

VEGA

103 m

2+1



11,4m



9,1m

103m²

Çiçek Kokularının Verdiği Huzur

| | |
|---------------|--------------------|
| - Salon | 21,3m ² |
| - Mutfak | 12,9m ² |
| - Yatak Odası | 16,3m ² |
| - Çocuk Odası | 14,9m ² |
| - Banyo | 4,6m ² |
| - WC | 3m ² |
| - Antre | 8,2m ² |
| - Balkon | 15,6m ² |



**PETERSON
KÖŞKÜ
120 m**

3+1

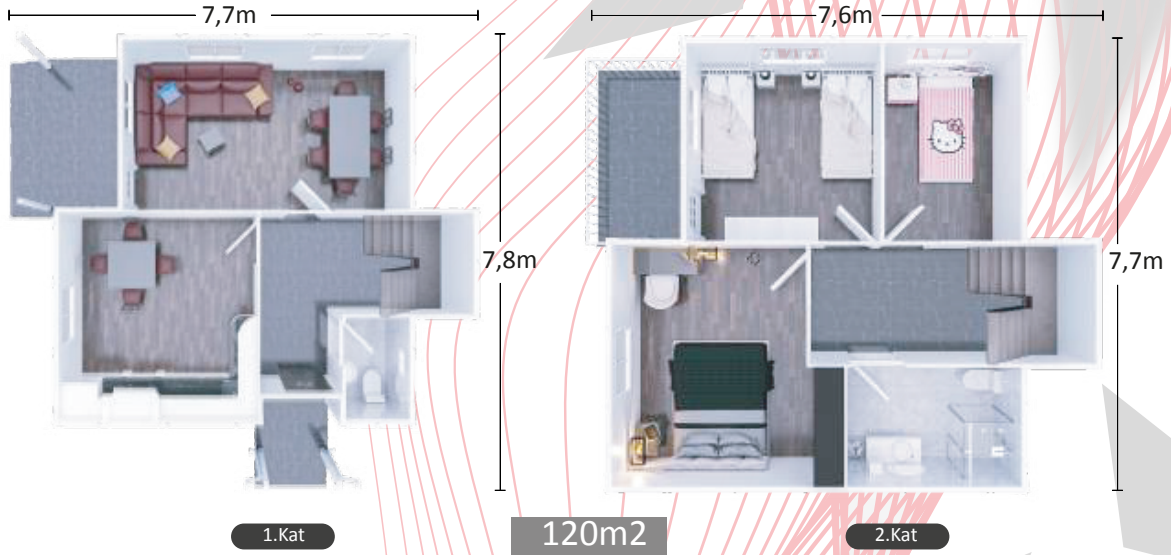

- Salon 18,6m²
- Mutfak 15,8m²
- WC 2,5m²
- Antre 5,7m²
- Balkon 6,3m²
- Giriş 2,6m²
- Merdiven 5,1m²

- Yatak Odası 14,5m²
- Çocuk Odası (B) 10,8m²
- Çocuk Odası (K) 7,5m²
- Banyo 5,8m²
- Antre 4,5m²
- Merdiven 5,1m²
- Balkon 6,3m²

3+1

YEŞİL KÖŞK

124 m

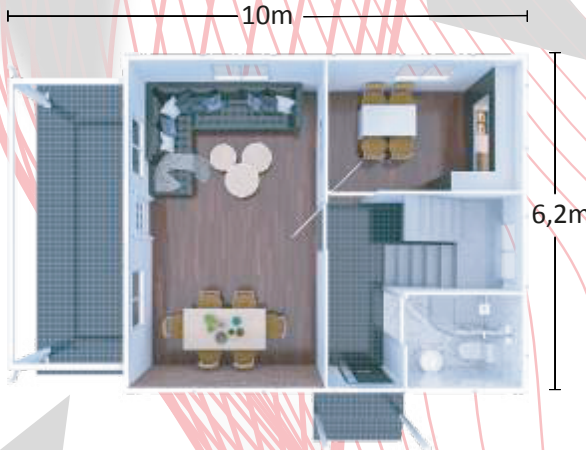

1.Kat



2.Kat

124m²

- Salon 23,6m²
- Mutfak 9,3m²
- Banyo 3,9m²
- Balkon 15,4m²
- Antre 5,4m²
- Merdiven 4,2m²

- Yatak Odası 13,6m²
- Çocuk Odası (B) 9,7m²
- Çocuk Odası (K) 9,3m²
- Banyo 3,9m²
- Antre 5,4m²
- Balkon 4,5m²
- Merdiven 4,2m²

Güzel
Başlangıçlar
İçin



MENEKŞE

128 m

3+1

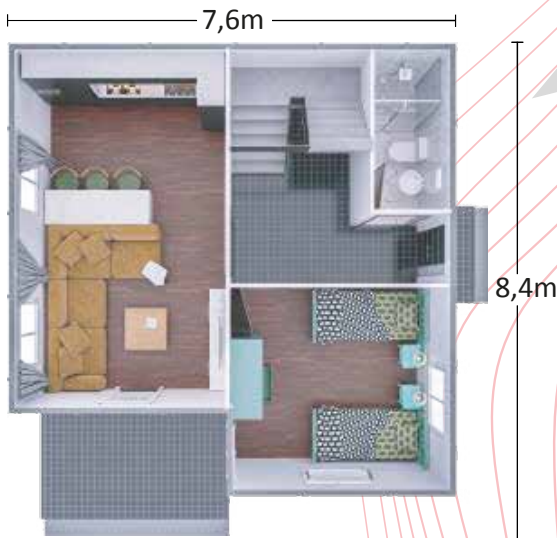

1.Kat



2.Kat

128m²

| | |
|----------------|--------------------|
| - Salon Mutfak | 20,8m ² |
| - Yatak Odası | 13m ² |
| - Banyo | 3,6m ² |
| - Antre | 7m ² |
| - Teras | 10,8m ² |
| - Merdiven | 4,2m ² |
| - Giriş | 1,5m ² |

| | |
|-------------------|--------------------|
| - Yatak Odası (1) | 16,4m ² |
| - Yatak Odası (2) | 17,2m ² |
| - Banyo | 4,7m ² |
| - Eyebeyn Banyo | 4m ² |
| - Teras | 9,5m ² |
| - Antre | 3,2m ² |
| - Merdiven | 4,2m ² |

Sessizliğin
Huzurunu
Hissetmek İçin

4+1

MERKÜR

148 m

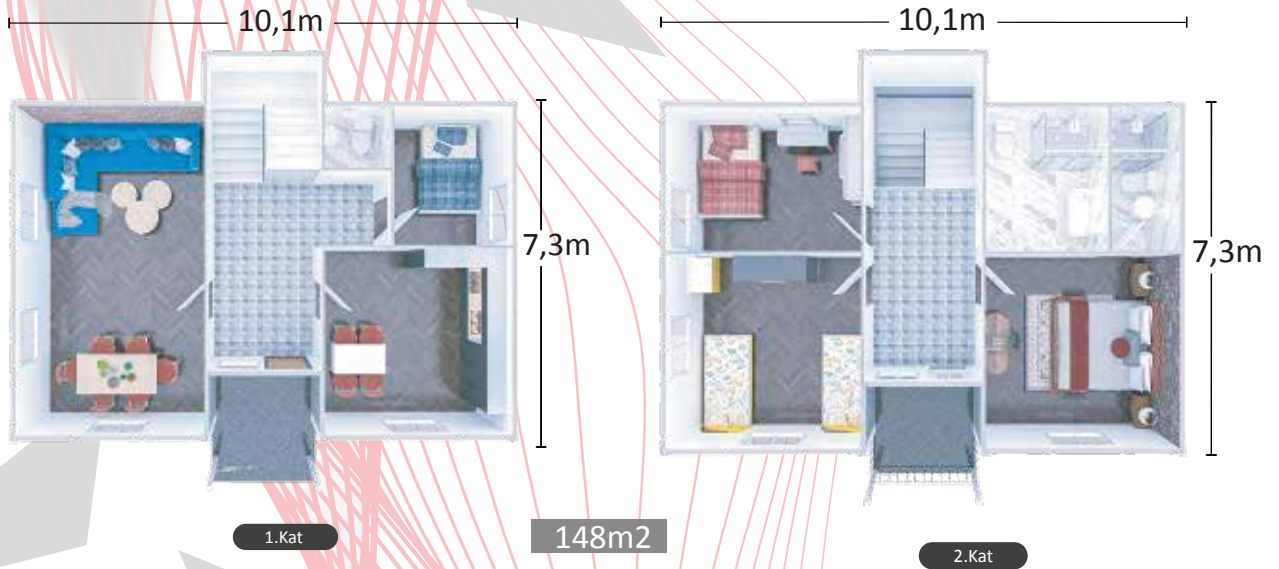

- Salon 25,1m²
- Mutfak 14,2m²
- Misafir Yatak Odası 6,7m²
- WC 1,7m²
- Antre 11,4m²
- Merdiven 5,5m²
- Veranda 5,1m²

- Yatak Odası (1) 14,3m²
- Yatak Odası (2) 10,6m²
- Çocuk Odası 14,2m²
- Banyo 6,7m²
- Evebeyn Banyo 3,7m²
- Antre 9,3m²
- Merdiven 5,5m²
- Veranda 5,1m²

Misyon

İnsanların barınma ihtiyaçlarını karşılamak için güvenli, estetik, ekonomik, hazır ve yaşanabilir mekanlar üretmek ve kaliteli yaşam özellikleri sunmak.

Vizyon

İnsanların barınma ihtiyaçlarına günümüz ileri teknolojisi ile kısa sürede pratik, ekonomik, kaliteli ve yapıcı çözümler sunmaktır. Bu amaçla ürün ve hizmet geliştiren ekibimiz, önce sağlık ve can güvenliği, kalitede süreklilik, çevreyi ve doğal kaynakları koruma bakış açısını benimsemiştir. Vizyonumuz şu temellere dayanmaktadır.

- Tam ve sürekli müşteri memnuniyeti,
- Satış ve sonrasında müşteri desteği,
- Çağdaş, çevreci ve fonksiyonel özelliklere sahip ürün yelpazesi,
- Sektör koşulları doğrultusunda müşteri taleplerini tam zamanında ve eksiksiz karşılamayı hedef edinen uzman ekip,
- Kalite, çevre ve iş güvenliği yönetim sistemini sürdürme ve iyileştirme bilinci içerisinde çalışan profesyonel, eğitimli kadro,
- Önce sağlık ve can güvenliği ilkesi,
- Çevreyi ve doğal kaynakları koruma, yaşayan dünyaya saygı ve kirliliği önleme felsefesi,
- Yönetim sistemini sürekli gözden geçirme ve değişen koşulları zamanında algılama,
- Elde ettiğimiz maddi ve manevi değerleri, ekip arkadaşlarımız, müşterilerimiz, tedarikçilerimiz ve toplumla paylaşma.



ANKA
P R E F A B R İ K

☎ 0 533 140 04 18

☎ 0 533 140 04 28

📧 ankaprefabrikcom

MERKEZ : Sütçüler Mah. Ankara Asfaltı No: 311/1 Kemalpaşa / İZMİR

ŞUBE 1 : 6108 Sk No:22 Işıkkent Bornova / İZMİR

ŞUBE 2 : AOSB Mah. Eski Havaalanı Cd. No:188 D1 Çiğli / İZMİR

ŞUBE 3 : Eski Küner Kavşağı Menderes / İZMİR